

WATERPROOF  
SYSTEM

# WETROOM CONCEPT



INSTALLATION GUIDE  
for a complete solution, including  
walls, floors and accessories



THE ULTIMATE  
FLOORING EXPERIENCE



## THE WETROOM CONCEPT

Introduction	3
A sense of wellbeing at home, in hospital and in a retirement home	4
Exclusive designs for a unique atmosphere	5
Create a safe environment	6
A collection of colours for serenity and vivid surroundings	8
A large range of accessories for an elegant finish	12



## INSTALLATION GUIDE

Drain installation	16
Floor covering installation	16
Wall covering installation	20
Tools required	23
Product description	24
Technical data	25
References	26
Guarantee and Maintenance	27

# TARKETT, THE WETROOM SOLUTION EXPERTS

For wellbeing and comfort wherever you are



**Tarkett pioneered the Wetroom Concept over 30 years ago. Today, Tarkett's complete Wetroom solution, including walls, floors and accessories, has reached close to 1 million installations.**

Wherever you are, the Tarkett Wetroom Concept offers a complete solution for wellbeing and comfort - colours and designs to suit every taste and safe, hygienic slip resistant surfaces.

Not only attractive, colours and designs are also ultra practical, tough, easy to clean and hygienic. They provide the easy access and the added safety and comfort that is so essential for people with reduced mobility in order to help make them feel at ease.

In addition to design ideas, this brochure provides a guide to successful installation of the Wetroom Concept.

# A SENSE OF WELLBEING AT HOME,

in hospital and retirement homes



With a wide range of colours and new designs, Tarkett's Wetroom Concept creates decors and ambiances that are just as suitable for a home, a retirement home, a hospital or hospitality environment.

# EXCLUSIVE DESIGNS

for a unique atmosphere

Tarkett's Wetroom Concept is a full colour concept. There's not only a choice of 88 colours, but also three new exclusive patterns for walls. The design possibilities are endless, but they don't stop at the wetroom door.

The concept is specially conceived to provide an all in one solution that takes a coordinated design from the wetroom through to an adjacent room or rooms by providing colour matches with other Tarkett ranges (Tapiflex & Accent Evolution, Tapiflex & Accent Excellence and ProtectWALL). The result is exclusive designs that create unique surroundings.



# A SAFE ENVIRONMENT

## HYGIENIC AND CLEAN

- Does not contribute to infection spreading
- Fewer joints reduce cleaning and trapped moisture



## HEALTHIER INTERIOR

- Contributes to optimal indoor air quality: Optima Multisafe, Granit Multisafe, Granit Safe.T and Aquarelle Wall HFS



- Contributes to better indoor air quality: Multisafe Aqua



## PROTECTED FROM SLIPS AND FALLS

The highest level of slip resistance on the market with Granit Multisafe (Class C according to NORM DIN 51097), specially recommended for retirement homes.

Slip resistance  
DIN 51097

<b>MULTISAFE AQUA</b> (Water Rings design)	CLASS A
<b>OPTIMA MULTISAFE</b>	CLASS B
<b>GRANIT SAFE.T</b>	CLASS B
<b>GRANIT MULTISAFE</b>	CLASS C
<b>MULTISAFE AQUA</b> (Stone & Fiber wood designs)	CLASS C



# A COLLECTION OF COLOURS

## Vinyl Wallcoverings

### AQUARELLE WALL HFS



Graphic lines

Vogue

Kiruma



3942 058

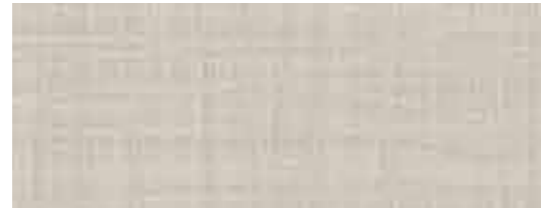

3942 050

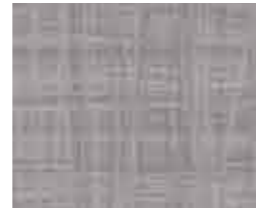

3942 051



3942 033



3942 043



3942 044



3942 037

## Vinyl Wallcoverings

### AQUARELLE WALL HFS



3942 059



3942 060



3942 052



3942 053



3942 054



3942 055



3942 034



3942 041



3942 042



3942 040



3942 031

Graphic lines

Vogue

Kiruma

## Vinyl Floorcoverings

### GRANIT MULTISAFE



3476 742



3476 382



3476 741

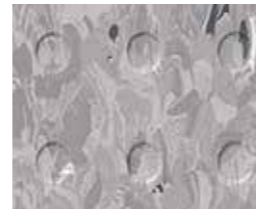

3476 383

### OPTIMA MULTISAFE



3052 886



3052 853



3052 866

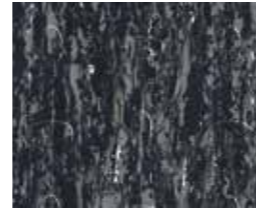

3052 845

### GRANIT SAFE.T



3052 697

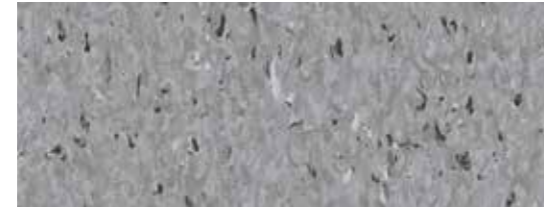

3052 698

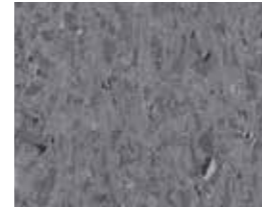

3052 699

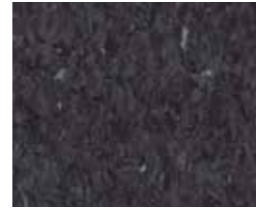

3052 700

### MULTISAFE AQUA



25910 000



25910 001



25910 003

Stone

## Vinyl Floorcoverings

### GRANIT MULTISAFE

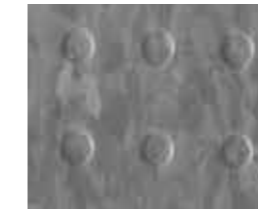

3476 740



3476 745



3476 746

### OPTIMA MULTISAFE



3240 873



3240 874

### GRANIT SAFE.T

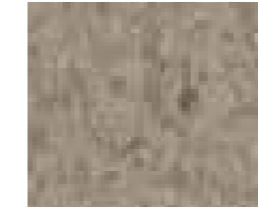

3052 704



3052 691

### MULTISAFE AQUA



25910 002



25912 202



25911 000

Stone

Fiber wood

Water rings

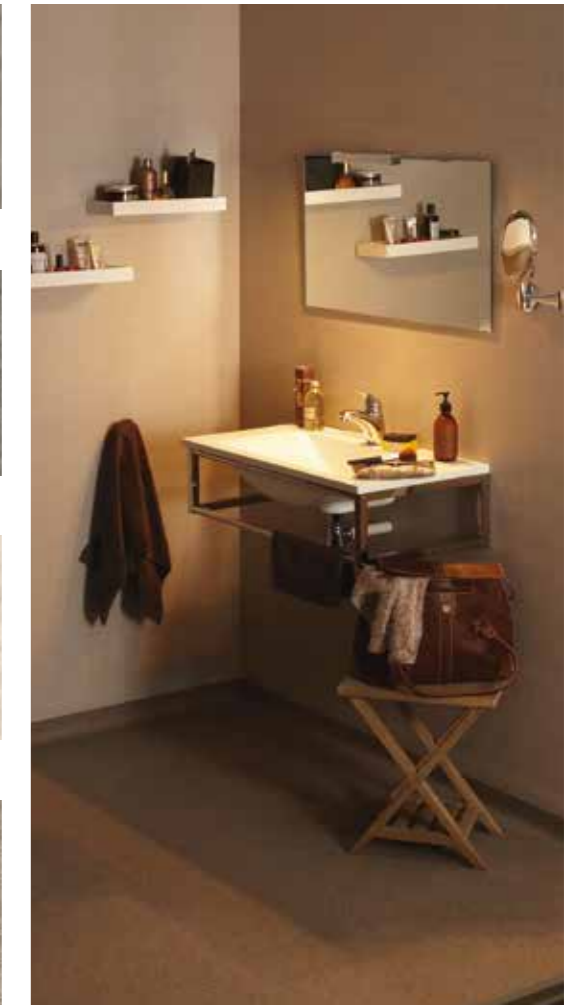

# A COLLECTION OF COLOURS

For a vivid atmosphere

## Vinyl Wallcoverings

### AQUARELLE WALL HFS



## Vinyl Wallcoverings

### AQUARELLE WALL HFS

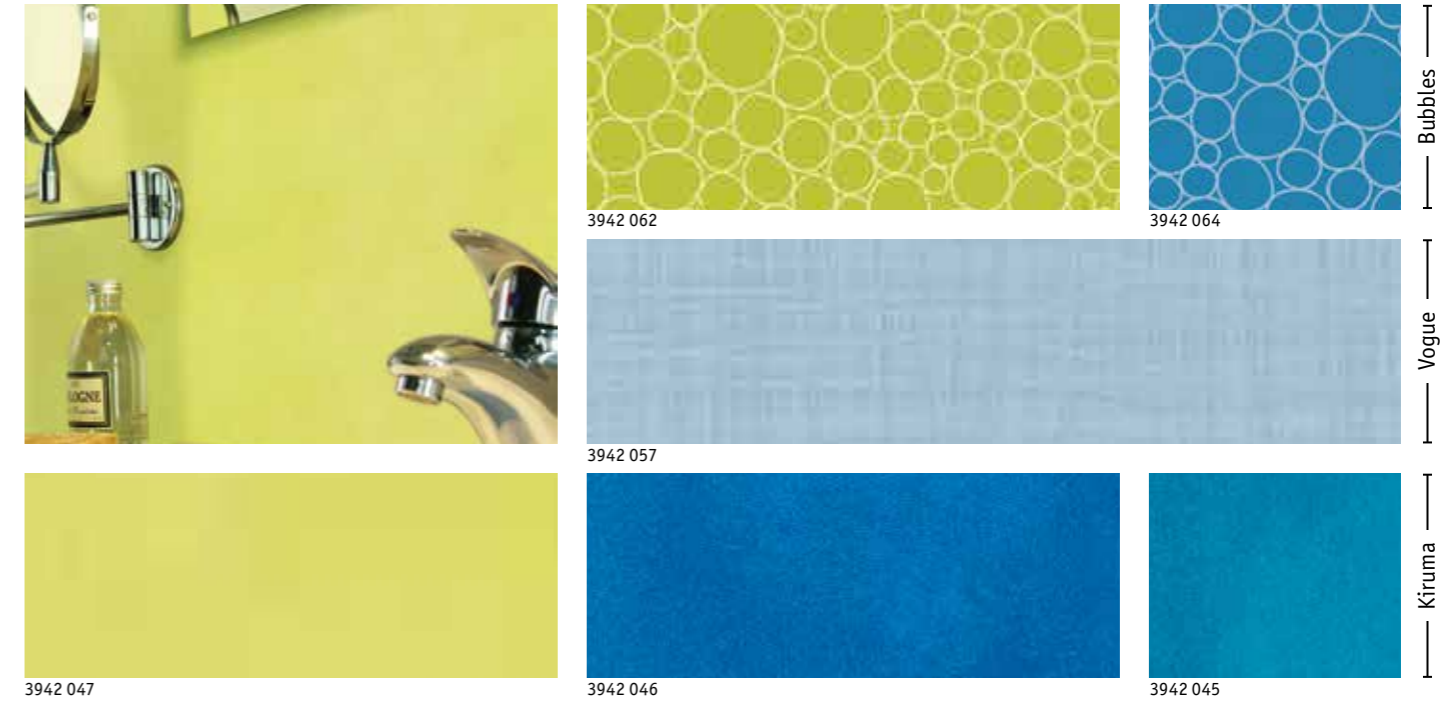

## Vinyl Floorcoverings

### GRANIT MULTISAFE



### OPTIMA MULTISAFE



### GRANIT SAFE.T



### MULTISAFE AQUA



## Vinyl Floorcoverings

### GRANIT MULTISAFE

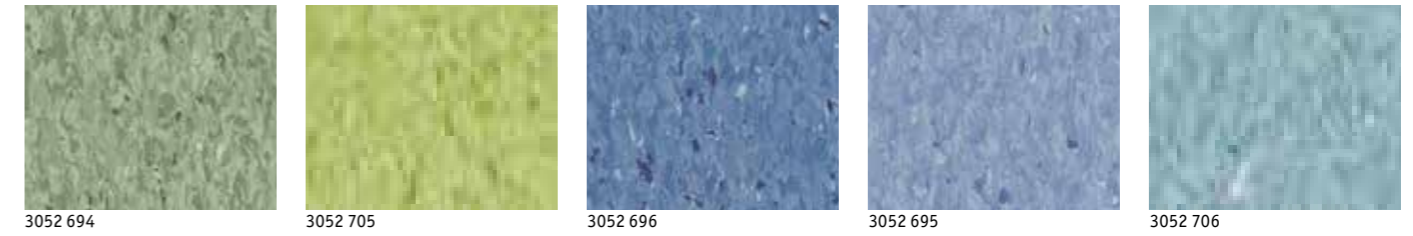
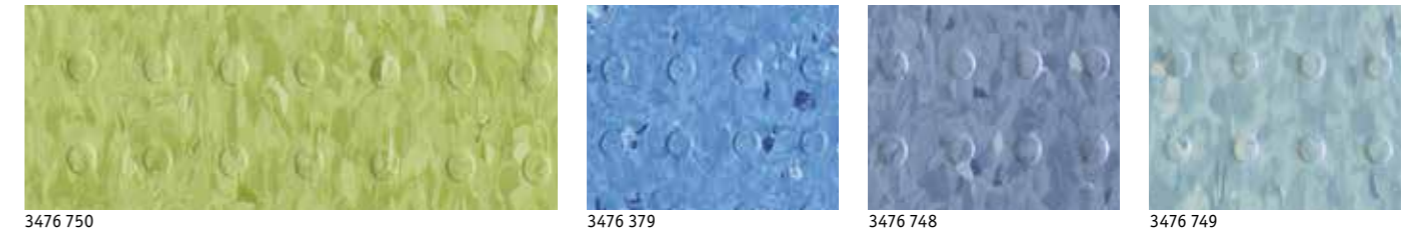

### MULTISAFE AQUA

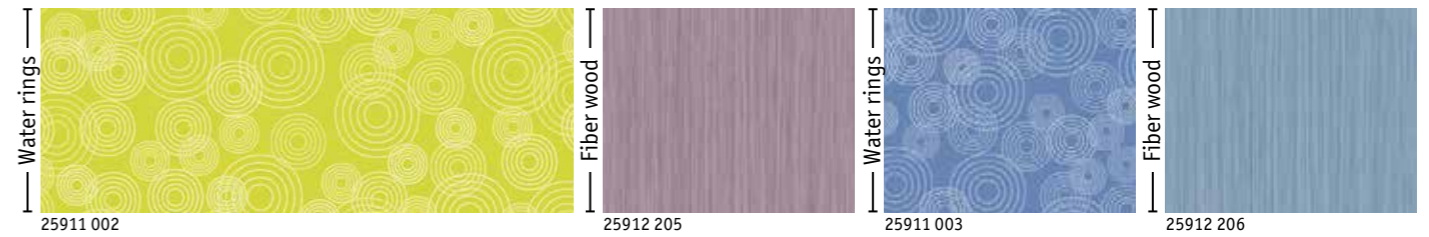

# A LARGE RANGE OF ACCESSORIES

For an elegant finish

It's the accessories that can make all the difference with an elegant finish.

Tarkett provides a wide range of accessories to complete the Wetroom Concept.



## COVE FORMERS AND PROFILES

### 1 Cover formers PA15, PA20 & PA30

**PA15**  
For added hygiene inside wall corners

**PA20 & PA30**  
For added strength at the most vulnerable point between wall and floor

References  
PA 15 (15x15 mm) / ref. 2661 7001  
PA 20 (20x20 mm) / ref. 1441 000  
PA 30 (30x30 mm) / ref. 1442 000

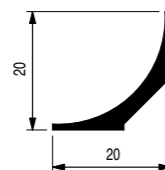

### 2 Flexible junction profiles PJ30 & PJ65

Designed to ensure a perfect watertight seal between covered floor covering and wall covering

References  
PJ 30 (30 mm) / ref. 1418 001  
PJ65 (65 mm) / ref. 2666 1001

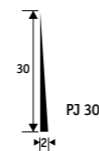

### 3 Threshold transition RTS & PTS

- exists in flexible rubber version (RTS)
- exists in rigid PVC version (PTS)

References

RTS Available in one colour  
Grey / ref. 1255 748

PTS Available in four colours  
Grey / ref. 2666 4001  
Dark grey / ref. 2666 4002  
White / ref. 2666 4003  
Beige / ref. 2666 4004

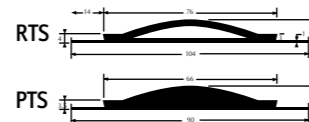

## A RANGE OF ADAPTED DRAINS

### 4 PVC and stainless steel drains and gratings

- large selection of siphons
- Several models of PVC gratings
- Several models of INOX gratings

## CLASSIC DRAINS

### VERTICAL OUTLET Four models

**SIPHON PURUS BRAGE 75**  
ref. 1416 005 outflow 3L/s

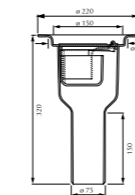

**SIPHON PURUS BRAGE 50**  
ref. 1416 004 outflow 2.5L/s

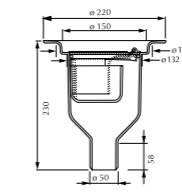

**SIPHON INOX 40\***  
ref. 1416 007 outflow 0.25L/s

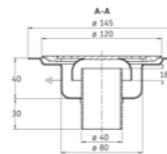

**SIPHON PURUS DUSCHBRUNN 50**  
ref. 1416 001 outflow 2L/s

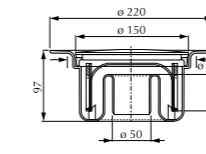

### HORIZONTAL OUTLET Three models

**SIPHON PURUS FREJA 50**  
ref. 1416 002 outflow 2L/s

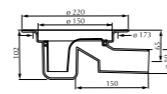

**SIPHON PURUS ODEN 75**  
ref. 1416 003 outflow 3L/s

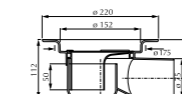

**SIPHON MINIMAX**  
ref. 1416 006 outflow 0.8L/s

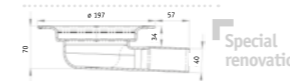

Special renovation

## GRATINGS

PVC



**Standard**  
ø130 1417 011  
ø150 1417 001

INOX



**Wave**  
ø130 2665 3001  
ø150 2665 2001



**Art Deco**  
ø130 2665 8001  
ø150 2665 7001



**Drop**  
ø130 2665 1001  
ø150 2665 0001

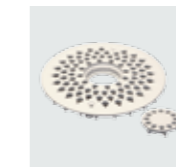

**Drop Grating "Drop" with hole for pipe**  
ø130 2665 9001  
ø150 2665 0001

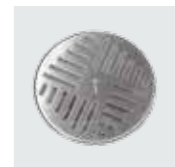

**Art deco**  
ø130 1417 013  
ø150 1417 010

## PURUS ITEMS



**Brage/Oden water trap**  
1417 005



**Freja water trap**  
1417 007



**Duschbrunn water trap**  
1417 008

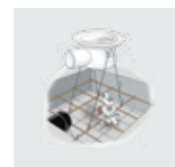

**Support**  
1417 004

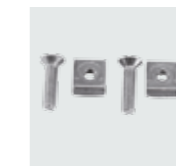

**Locking set**  
1417 006

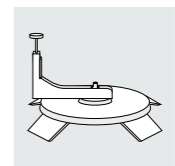

**Purus knife** 1417 003  
Extra blades for Purus knife (x5) 1417 016



**Clamping ring: 150mm**  
1417 002

# A LARGE RANGE OF ACCESSORIES

For an elegant finish

## A RANGE OF ADAPTED DRAINS

### RECTANGULAR DRAINS



Dimensions  
Length: 300, 600, 900 mm  
Width: 120 mm  
Height: 143\* mm  
Outflow: 0.80 L/sec

\* Note that the height depends on which gully you choose

#### TYPE AND DIMENSIONS

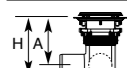
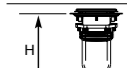
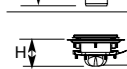
Gully type	Dim	Length (mm)		
		300	600	900
 Side-/Side Side outlet	ø50 or ø75 H:	132	132	137
	ø50 A:	107	107	112
	ø75 A:	95	95	100
 Bottom outlet	ø50 H:	187	187	192
	ø75 H:	212	212	217
 Low gully	ø50 H:	79	79	84
	ø50 A:	54	54	59

Please refer to chart on page 26 for all references.

#### REFERENCES\*

300 / 600 / 900 mm x 120 mm - Vertical outlet and side outlet  
50 and 75 mm diameter - Low gully vertical and side outlet

Inox line 300 V0 50	2668 0001
Inox line 300 S0 50	2668 1001
Inox line 300 V0 75	2668 2001
Inox line 300 S0 75	2668 3001
Inox line 300 LS 50	2668 5001
Inox line 600 V0 50	2668 6001
Inox line 600 S0 50	2668 7001
Inox line 600 V0 75	2668 8001
Inox line 600 S0 75	2668 9001
Inox line 600 LS 50	2669 1001
Inox line 900 V0 50	2669 2001
Inox line 900 S0 50	2669 3001
Inox line 900 V0 75	2669 4001
Inox line 900 S0 75	2669 5001
Inox line 900 LS 50	2669 7001

\*on request

## WALL BORDERS

2590 0034 White  
Thickness: 0.92 mm  
Roll length: 30 - 35 lm

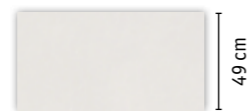

49 cm

2590 0037 Extra white  
Thickness: 0.92 mm  
Roll length: 30 - 35 lm



49 cm

## WATERPROOF PIPE COLLARS

Offer an efficient way to achieve a watertight finish for small diameter pipework in a variety of sizes



#### STOSETT LOW TOP MEMBRANE

Diameter*	Reference	Packaging
8 - 12 mm	1420 001	24 sleeves + 12 clamps
11 - 15 mm	1420 002	24 sleeves + 12 clamps
15 - 19 mm	1420 003	24 sleeves + 12 clamps
18 - 22 mm	1420 004	24 sleeves + 12 clamps
21 - 26 mm	1420 005	24 sleeves + 12 clamps
26 - 31 mm	1420 006	24 sleeves + 12 clamps
30 - 35 mm	1420 007	24 sleeves + 12 clamps
35 - 42 mm	1420 008	6 sleeves + 3 clamps
100 - 127 mm	1420 009	1 sleeve
Adhesive for Stossett	1460 010	1 tube = 160 ml

\* The first figure indicates the diameter of the upper part; the second indicates the diameter at the groove.

## WELDING RODS

Plain and multicolour welding rods to complement chosen floor coverings. Please refer to chart on page 26 for more details.

# WETROOM CONCEPT INSTALLATION PROCESS

This section of the brochure gives you a step-by-step installation guide for the Wetroom Concept including floors, walls and main accessories.





# FLOOR COVERING INSTALLATION

## DRAIN INSTALLATION

The drain should be installed by a qualified plumber as part of the wetroom installation and according to the instructions provided with the drain and the recommended installation standards.



## FLOOR COVERING INSTALLATION (11 STEPS)

The Wetroom Concept includes 3 types of homogeneous vinyl flooring:

- Multisafe Granit
- Granit Safe. T
- Multisafe Optima

One type of heterogeneous vinyl flooring:

- Multisafe Aqua

When a floor covering is used with a traditional mortar or concrete floor, the humidity content must not be over 4.5%, using a calcium chloride test kit to a minimum depth of 4 cm.

## INSTALLATION STANDARDS

The floor must have a  $\geq 1\%$  pitch towards the drain.

Where the design does not include screens or other barriers to contain the water, the pitched area should include the entire zone exposed to water, that is at least 1.8 meters from the shower attachment and the drain.

Fixed or mobile, vertical screen(s) at least 1.8 meters high can be used to contain spray from the shower. In this case, the pitched area should include:

- The entire shower zone inside vertical screen(s).
- All unprotected areas exposed to water, that is at least 1.8 meters from the shower attachment and the drain.

The drain must be at least 30 cm from the walls.

The pipework should not diminish the integrity of the floor covering. A suitable casing (or STOSSET collars for renovations) should be provided if this is not possible.

Please see page 14 for STOSSET details.

## 1 PREPARING THE SUBFLOOR

The PVC flooring requires a subfloor with a minimum pitch of 1 cm per meter after using a P3 self-leveling compound.

Check the subfloor for humidity level, surface cohesion, porosity, flatness, a curing compound, and cracks.

Where micro cracks  $\leq 0.3$  mm exist, use a primer recommended by the manufacturer before applying the screed.

There should be no expansion joints.

## 2 GLUING THE COVE FORMERS

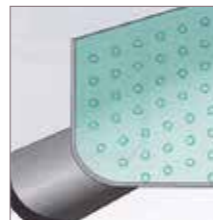

Apply cove former around the entire edge of the room, double gluing with a contact adhesive and scribe the edges around the doorframe.

## 3 INSTALLING THE FLOOR COVERING

Measure the sections of floor covering taking care to include enough to cover the cove formers. 24 hours before use, cut the appropriate lengths and store at a minimum ambient temperature over  $15^{\circ}\text{C}$ . During gluing, the sub floor temperature must be  $\geq +12^{\circ}\text{C}$ , the dew point temperature no lower than  $3^{\circ}\text{C}$  and the atmospheric temperature over  $15^{\circ}\text{C}$ .

## 4 TRACING THE COVING

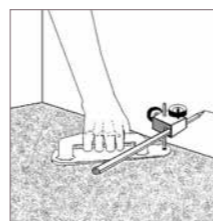

Use a scribe (Refer to code 11, p. 23) to mark all round the walls to a minimum height of 10 cm.

## 5 MARKING UP THE SECTIONS

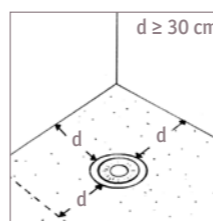

Sections reversed: all welded joints must be at least 30 cm from the drain.

## 6 INSTALLATION

Bring the edges of the sections together.

Lift the part that covers the drain and install the base (foot) of the PURUS knife (see p. 13) in the gully.

Apply an acrylic adhesive recommended by Tarkett to the subfloor using a TKB A2 fine-toothed spatula (about  $300\text{g}/\text{m}^2$ ). Allow the glue to become tacky and then position the floor covering section or sections. Rub down carefully. Repeat with the other pieces.



## 7 INSTALLING THE DRAINCLAMPING RING

1 When the floor covering is in place, press it down until it is perforated by the pivot of the PURUS knife (see p. 13). Attach the arm of the knife and cut the hole (see p. 23) in the vinyl.

2 Remove the cutter.

3 Use a hot air gun (Refer to code 1, p. 23) to heat the floor covering so that the drain can be positioned properly.

4 Position the clamping ring (blue) on the floor covering and push to fix in the drain. Put the protective grating in place (filter).



# FLOOR COVERING INSTALLATION

## 8 COVING

**1** Use a corner roller (Refer to code 2, p. 23) and hot air gun (Refer to code 1, p. 23) to make sure that the floor covering is smooth and pushed well into the floor/wall angle.

Cove the flooring by double gluing the subfloor and the back of the floor covering, applying an acrylic double contact adhesive with a spatula or a brush. Carefully follow the safety requirements for this type of glue and observe the tack time.

**2** Once the glue has become tacky to the touch, fold the floor covering onto the wall.

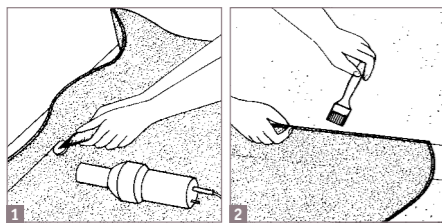

INSIDE CORNER (A)

**3A** Trim the excess material starting in a corner 5mm from the floor.

**4A** Use the corner roller (Refer to code 2, p. 23) to apply the floor covering in the corner.

**5A** Make a 45° cut using a set square or angle (Refer to code 10, p. 23).

Trim the coving to 10cm using a combined scribe/mixed marking gauge (Refer to code 11, p. 23) or a suitable rule and cutting tool.

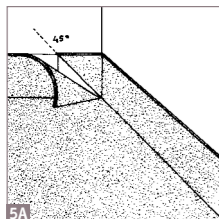
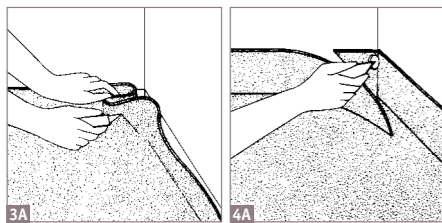

## OUTSIDE CORNER (B)

**3B** Cut out a triangular section from the floor covering at 45° either side of the corner using an angle (Refer to code 10, p. 23) if required.

**4B** The triangle must finish 5mm from the floor.

**5B 6B** Adjust the size of the cutaway piece, cut a groove into the back and apply glue to the before applying to the corner space.

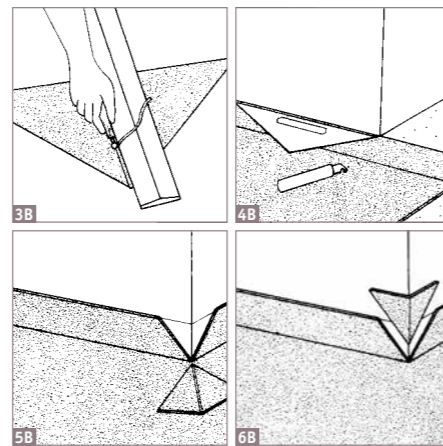

## 9 HOT WELDING

We recommend leaving the floor for 24-48 hours after installation before welding.

**1** Welding the plinth. Scribe the cuts and joints using a wall groover or adjustable groover (Refer to code 3, p. 23). The corners can be hot welded using a swan neck nozzle or angle finishing nozzle (Refer to code 12, p. 23).

**2** Use welding rods to weld the floor joint(s). Use a speed nozzle (Refer to code 5, p. 23) and trim the welding rod with a tool designed for studded flooring (Refer to code 9, p. 23).

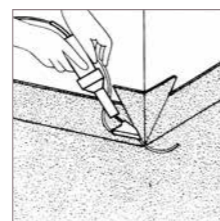

## 10 INSTALLING STOSETT WATERPROOF PIPE COLLAR

Wherever possible the project design should maintain flooring integrity by grouping vertical outlets in a conduit or casing along the partition.

A watertight finish is always possible for small diameter piping providing that: there is sufficient space (5 cm between and behind the pipes); special protection using collars after the floor covering has been installed.

Before installing the collar, the cuts (floor and wall) should be hot welded and the area around the pipes trimmed (depending on the STOSSET collar diameter).

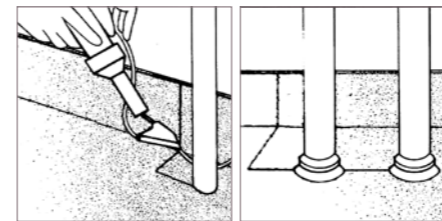

The following diagrams show the different stages:

**1** Remove the RADONIX membrane at the base of the pipe work.

**2** After cutting the collar, apply the adhesive (or liquid solder cold welding such as V1008 or Werner Muller) around the base.

**3** Position the collar and glue the joint (adhesive or V1008).

**4** Adjust the clamping ring to keep the collar in place while the liquid solder dries.

**5** Remove the ring.

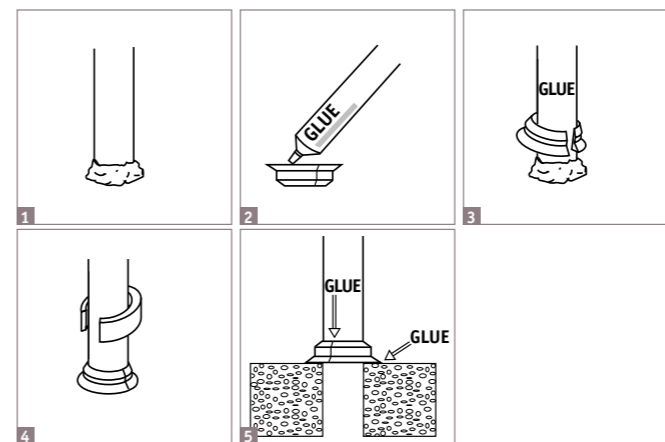

## STOSETT LOW TOP MEMBRANE

Diameter*	Reference	Packaging
8 - 12 mm	1420 001	24 sleeves + 12 clamps
11 - 15 mm	1420 002	24 sleeves + 12 clamps
15 - 19 mm	1420 003	24 sleeves + 12 clamps
18 - 22 mm	1420 004	24 sleeves + 12 clamps
21 - 26 mm	1420 005	24 sleeves + 12 clamps
26 - 31 mm	1420 006	24 sleeves + 12 clamps
30 - 35 mm	1420 007	24 sleeves + 12 clamps
35 - 42 mm	1420 008	6 sleeves + 3 clamps
100 - 127 mm	1420 009	1 sleeve
Adhesive for Stossett	1460 010	1 tube = 160 ml

\* The first figure indicates the diameter of the upper part; the second indicates the diameter at the groove.

## NOTE

If there is no equivalent collar for unusual diameter pipework, create one from the floor covering (welded to the base and vertically at the junction) or use a suitable caulking mastic (polyurethane or MS polymer, ref. Bostik MS 107).

## 11 INSTALLING EQUIPMENT (AFTER COMPLETION)

Our 10-year floor and wall guarantee only covers attachments for accessories and sanitary equipment (required for the plumbing) if suitable fixings are used. Screws must only be used with watertight chemical rawplugs or rawplugs with a suitable waterproof mastic (polyurethane or MS polymer, ref. Bostik MS 107).

Waterproof mastic must also be applied where surfaces meet, in particular: basin, lavatory, wall-mounted flush, grab rail, trap, etc.

Example: to install a lavatory (preferably with wall-mounted flush) follow the instructions above and before putting it into place also apply waterproof mastic where it will meet the wall.

The supporting framework and partition must be sufficiently rigid to prevent movement when the lavatory is used, which could damage the wall covering.

# WALL COVERING INSTALLATION

## WALL COVERING INSTALLATION (8 STEPS)

### 1 PREPARING THE WALLS/SUBSTRATE

It must be flat, solid, sound, dry, clean, normally absorbent and also crack-free.

Any old coverings must be removed first.

Apply a primer suitable for the material and then the glue (never use paint even diluted).

Incoming and outgoing pipes should have a maximum diameter of 5 cm.

A 5 cm gap must be left between the pipework and the wall to leave room to hang Aquarelle Wall HFS.

### 2 PREPARING THE WALL COVERING

Precut 24 hours before gluing and keep at a minimum ambient temperature of + 15°C.

### 3 INSTALLING THE FLOOR/WALL TRANSITION STRIP (REF. PJ 30 & PJ 65)

Apply a PJ 30 transition strip to compensate for the thickness of the covering, double gluing with an acrylic double contact adhesive with a spatula or a brush.



### 4 INSTALLING THE WALL COVERING

The wall covering should be installed so that the joints are as far away from the wet zone as possible and at least 10 cm from a corner. Joints should never be made in a corner. Measurements should include a minimum extra 3 cm to overlap the covering.

Before installing the wall covering, remove the studs with a quarter moon knife. This allows for a smoother finish when creating the coving up and overlapping wall covering over the floor covering by 3 cm.

#### VERTICAL INSTALLATION

Position the sheets vertically to room height (sheets reversed).



#### HORIZONTAL INSTALLATION

Aquarelle Wall HFS can be installed horizontally, but a Wall Border (49 cm width) must be used to ensure that the full height of the room is watertight. The Border should be applied once the Aquarelle Wall HFS wall covering is in place, and should overlap the upper edge by at least 2 cm (only use acrylic adhesive). The Wall Border frieze is positioned on the bottom edge for the best visual effect.



#### Wall borders

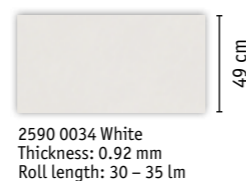

### 5 GLUING

Take the full width of a floor covering section and mark a plumb line on the wall from ceiling to plinth. Use a fine-toothed spatula TKB A4 (200/250 g/m<sup>2</sup>) to coat the defined area with an acrylic adhesive recommended by Tarkett.

Wait the appropriate tack time for the glue and then line up the first section with the plumb line and press in to place using a cork wedge (Refer to code 14, p. 23) and pushing air bubbles from top to bottom and centre to edges.

Glue the next area and hang the second section of wall covering reversed and either position tightly edge-to-edge with the first (make sure that the edges are in good condition) or overlapping the edges by around 3 cm. If you overlap the sheets, cut the joint using a hot air gun (Refer to code 1, p. 23) and a straight blade, or a combined scribe/marking gauge (Refer to code 1, p. 23).

#### INSIDE CORNER

To work round a corner, hang the wall covering up to the corner and fold it back on itself. Create a fold against the corner the full height of the sheet and then use an angle roller (Refer to code 2, p. 23) and taking care to press each side of the corner starting from the bottom. If the corner of the substrate isn't straight, cut the wall covering vertically at least 10 cm from the corner and continue with the next section.

#### OUTSIDE CORNER

Double glue an area 5 cm from each side of the edge using an acrylic double contact adhesive with a spatula or a brush. Press the wall covering in to place on one side up to the corner. Use a hot air gun (Refer to code 1, p. 23) and bend the wall covering around the corner, pressing into the angle with a cloth and outside corner roller. If the substrate corner is not straight, cut the wall covering plumb 10 cm from the corner and continue with the next sheet.

### 6 COVERING THE COVING

Trim off the Aquarelle Wall HFS wall covering at 7 cm from the floor (a 3 cm overlap with the coving) using a combined scribe/marking gauge (Refer to code 11, p. 23).

#### NOTE

Excess material in the corner can be incorporated by using a hot air gun (Refer to code 1, p. 23) and corner roller (Refer to code 2, p. 23).

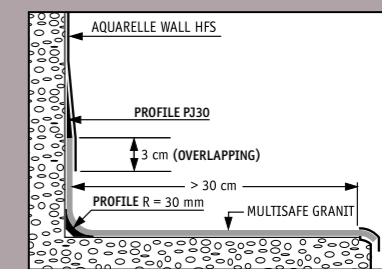

With cove former

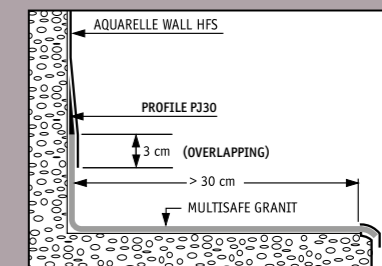

Heat formed without cove former

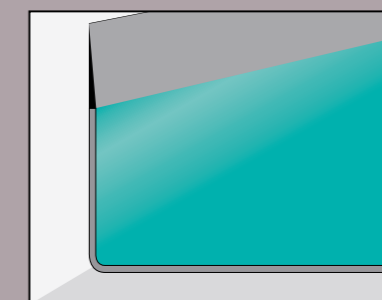

PJ 30

# WALL COVERING INSTALLATION

# TOOLS REQUIRED

## 7 HOT WELDING THE JOINTS

Leave for 24-48 hours before hot welding the joints using welding rods as follows:

- Temperature of the substrate  $\geq +12^{\circ}\text{C}$ , ambient temperature  $\geq +15^{\circ}\text{C}$

**1** Open the joint using a grooving tool (Refer to code 3, p. 23) and a rule for support (Refer to code 4, p. 23).

**2** Use the speed welding nozzle (Refer to code 5, p. 23) and work from top to bottom.

**3 & 4** Use the Mozart knife (Refer to code 16, p. 23) or a quarter moon knife (Refer to code 6, p. 23) to trim in two stages, pre-trimming using an adjustable trimmer (Refer to code 7, p. 23) and finish with the quarter moon knife (Refer to code 6, p. 23).

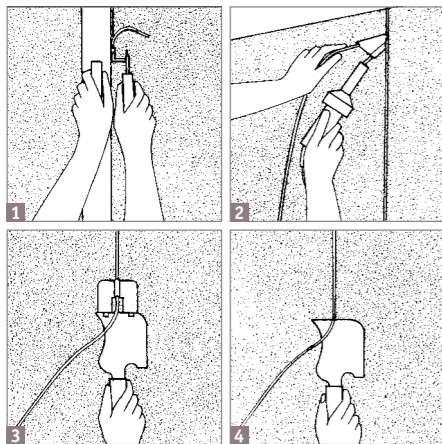

## 8 CAULKING

Once the floor and wall coverings are in place, waterproof the joints around the door frame (windows, frames, ceiling etc.) using a mastic designed for this purpose (polyurethane or MS polymer, Ref. Bostik MS 107). Do the same for any fixtures installed after the Aquarelle Wall HFS wall covering.

## 9 CONNECTING TO A DRY ROOM

In general: hot weld the floor covering to the flooring used in the adjacent room.

### WETROOM THRESHOLD TRANSITION STRIP

Tarkett offers 2 types of threshold transition strips for use with the Wetroom concept.

#### RTS: Rubber threshold strip

- > made from 10 cm wide grey rubber with a central air pocket that stops water and flattens easily under foot or wheels

- > available in 20 ml reels

- > fixed into place with a polyurethane adhesive and the floor coverings glued on to the 1 cm strip on either side using an acrylic adhesive

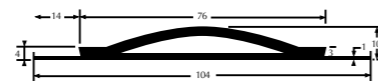

#### PTS: PVC threshold strip

- > made from 9 cm wide solid pvc

- > available in 4 colours

- > available in 10 strips of 3 lm in a box

- > may be hot welded with a welding rod for perfect water tightness

- > fixed into place adhesive with a polyurethane adhesive and the floor coverings glued on to the 1 cm strip on either side using an acrylic adhesive

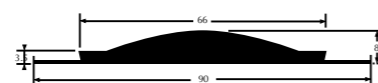

CODE	TYPE OF TOOL	FLOOR	WALL	JANSER	ROMUS
1	Hot air gun	X	X	226 110 000	95 047
2	Corner roller	X	X	224 400 123	95 135
3	Wall groover or adjustable groover		X		95 125
4	Guide rule		X	262 601 000	91 580
5	High speed hot air nozzle -	X	X	224 700 300	95 030
5	High speed nozzle	X	X	224 400 300	
5	Tarkett super high speed welding nozzle (Ref. 1258 012)		X		
6	Quarter moon knife	X	X	262 621 000	95 140
7	Adjustable trimmer	X	X	262 625 000	95 150
8	Traditional blowtorch	X	X	224 962 000	95 074
8	("welder")	X	X	224 818 000	95 080
9	or special wall seam plane (studded flooring)	X	X	262 626 500	95 172
9	or trimming tool slim		X	262 609 100	
9	or "slim" or "trim" trimmer		X	262 609 300	
10	90° angle template	X			95 445
10	and flat angle template for coving	X			95 446
11	Scriber or		X	222 430 000	95 430
11	combined scriber/marketing gauge		X	262 130 000	
12	Swan neck nozzle or	X		224 810 040	95 039
12	Corner finishing nozzle	X		224 810 050	
13	Trimming gouge	X		262 610 000	95 160
14	cork wedge/squeegee	X	X	262 380 000	93 145
15	stainless steel trowel		X		93 150
16	Mozart knife	X	XX	262 636 000	95 130

## RECOMMENDED ADHESIVES

Tarkett regularly test the main adhesives on the market to check that they are compatible with its products. The manufacturer is responsible for the quality of the adhesives and the installer for their use according to the manufacturer's instructions. Surfaces must be sound, solid, dry, flat, clean, suitably absorbent and not subject to later rises in humidity. It may be necessary to prepare the surfaces before installation according to the specific instructions or use for the adhesive and the NF DTU 53.2 P1-1 standard.

Acrylic adhesive should be applied using a fine toothed spatula TKB A4 (d.p.t 200 . 250 g/m<sup>2</sup>) for Aquarelle Wall HFS and TKB A2 (d.p.t environ 300 g/m<sup>2</sup>) for Multisafe Granit, Granit Safe. T and Multisafe Optima. Consideration should be given to the local climate in relation to tack time, drying etc.

### TECHNICAL ASSISTANCE

If your business does not yet have experience in installing the Wetroom Concept please contact your local Tarkett sales office for advice and assistance.

# PRODUCT DESCRIPTION

# TECHNICAL DATA

## MULTISAFE OPTIMA



■ Is a studded homogeneous PVC flooring available in 2 m widths, 2 mm thick + 0.25 mm studs. It has slip resistance B as determined by bare feet on an angled ramp (angle  $\geq 18^\circ$  according to standard DIN

51097). This flooring does not contribute to infection spreading. It has a 0.03 mm wear layer (NF eN 433).

■ Is 100 % recyclable and comes with a 10-year Guarantee. Emissions of volatile organic compounds (VOC) are lower than  $10 \mu\text{g}/\text{m}^3$  (tVoc after 28 days).

## GRANIT MULTISAFE



■ Is a studded homogeneous PVC flooring available in 2 m widths, 2 mm thick + 0.5 mm studs. It has slip resistance C as determined by bare feet on an angled ramp (angle  $\geq 18^\circ$  according to standard DIN

51097). This flooring does not contribute to infection spreading. It has a 0.03 mm wear layer (according to NF EN 433).

■ Is 100 % recyclable and comes with a 10-year Guarantee. Emissions of volatile organic compounds (VOC) are lower than  $10 \mu\text{g}/\text{m}^3$  (tVoc after 28 days).

## MULTISAFE AQUA



■ Is a slip resistant heterogeneous vinyl flooring available in 2m width, 2mm thick. It has slip resistance Class A (Water Rings design) and Class C (Stone & Fiber Wood designs) as determined by bare feet on an

angled ramp (angle  $\geq 18^\circ$  according to standard DIN 51097). The surface is strengthened and made easier to maintain by TopClean XP polyurethane surface treatment.

■ Is 100% recyclable and comes with a 10-year guarantee. Emissions of volatile organic compounds (VOC) are lower than  $100\mu\text{g}/\text{m}^3$  (TVOC after 28 days).

## GRANIT SAFE.T



■ Is a slip resistant homogeneous PVC flooring available in 2 m widths, 2 mm thick. It has slip resistance class B as determined by bare feet on an angled ramp (angle  $\geq 18^\circ$  according to standard DIN 51097). The surface

is strengthened and made easier to maintain by Safety Clean XP, a photoreticulated polyurethane treatment. This flooring does not contribute to infection spreading. It has a 0.03 mm wear layer (NF eN 433).

■ Is 100 % recyclable and comes with a 10-year Guarantee. Emissions of volatile organic compounds (VOC) are lower than  $10 \mu\text{g}/\text{m}^3$  (tVoc after 28 days).

## AQUARELLE WALL HFS



■ Is a PVC wall covering especially suitable for use in wet areas. This flooring does not contribute to infection spreading. It is available in 2 m widths and is 0.92 mm thick.

## WALL BORDER

■ The PVC wall border is especially suitable for use in wet areas. It helps preventing infection spreading. It comes in lengths 0.49 m x 30 ml and is 0.92 mm thick.

## TARKOMOUSSE

■ Is a glass fibre reinforced PVC underlay with a foam underside. Used with a floor covering, it offers acoustic reductions of 19 dB with Multisafe Granit and 17 db with Granit Safe.T and Multisafe Aqua (Technical data and installation instructions are available upon request). It comes in 2 meter widths.

## Specification

**Aquarelle Wall HFS**  
Compact printed vinyl wallcovering for use in wetroom.  
Product standard: EN 15102.

**Granit Multisafe**  
Homogeneous single layered vinyl flooring with studded surface.  
Product standard: EN 649.

**Optima Multisafe**  
Homogeneous vinyl flooring with studded surface.  
Product standard: EN 649.

**Granit Safe.T**  
Slip resistant homogeneous vinyl flooring.  
Product standard: EN 13845.

**Multisafe Aqua**  
Compact slip resistant printed design heterogeneous vinyl flooring for use in wetroom.  
Product standard: EN 649.

CERTIFICATION & CLASSIFICATION	STANDARDS	Aquarelle Wall HFS	Granit Multisafe	Optima Multisafe	Granit Safe.T	Multisafe Aqua
CE Certification	EN 14041	Yes	Yes	Yes	Yes	Yes
Classification	EN 259	Heavy duty	-	-	-	-
	ISO 10874 - EN 685 Commercial	-	31	31	34	33
	Industrial	-	-	-	43	42
TECHNICAL CHARACTERISTICS	STANDARDS	Aquarelle Wall HFS	Granit Multisafe	Optima Multisafe	Granit Safe.T	Multisafe Aqua
Wear layer thickness	ISO 24340 - EN 429	0.12 mm	2.00 mm	2.00 mm	2.00 mm	2.00 mm
Total thickness	ISO 24346 - EN 428	0.92 mm	2.50 mm	2.25 mm	2.00 mm	0.55 mm
Total weight	ISO 23997 - EN 430	1 500 g/m <sup>2</sup>	3 010 g/m <sup>2</sup>	2 820 g/m <sup>2</sup>	2 950 g/m <sup>2</sup>	3 100 g/m <sup>2</sup>
Form of delivery	Sheet (rolls)	Rolls: 35 lm x 2 m Borders: 49 cm x 30-35 m	25 lm x 2 m	25 lm x 2 m	25 lm x 2 m	20 lm x 2 m
TECHNICAL PERFORMANCES	STANDARDS	Aquarelle Wall HFS	Granit Multisafe	Optima Multisafe	Granit Safe.T	Multisafe Aqua
Dimensional stability	ISO 23999 - EN 434	0.80 %	0.40 %	0.40 %	0.40 %	$\leq 0.10 \%$
Curl resistance	Yes	Yes	Yes	Yes	Yes	$\leq 8\text{mm}$
Reaction to fire	EN 13501-1	B-s2, d0 on gypsum plaster-board and on A1 or and A2 substrate	Class B <sub>i</sub> s1	Class B <sub>i</sub> s1	Class B <sub>i</sub> s1	B <sub>i</sub> s1 glued over any A2 <sub>i</sub> or A1 <sub>i</sub> substrate (on cement) C <sub>i</sub> s1 glued over any derivative wood substrate
Marine equipment	EN 13501-1	-	8 kW/m <sup>2</sup> pass	8 kW/m <sup>2</sup> pass	8 kW/m <sup>2</sup> pass	-
	EN ISO 11925-2	-	-	-	-	-
Residual indentation	IMO FTPS Part 5 and 2	-	-	-	-	-
	IMO Res. A653	-	-	-	-	-
Castor chair test	Average measured value	-	0.02 mm	0.02 mm	0.02 mm	$\leq 0.10 \text{ mm}$
	ISO 24343-1 - EN 433 requirement	-	$\leq 0.10 \text{ mm}$	$\leq 0.10 \text{ mm}$	$\leq 0.10 \text{ mm}$	$\leq 0.10 \text{ mm}$
Bare foot test	ISO 4918 - EN 425	-	-	-	Suitable	-
	DIN 51097	-	Class C (27°)	Class B (18°)	Class B (18°)	Class A: design Water rings Class C: designs Stone and Fiber wood
Underfloor heating	-	-	Suitable - max 27° C	Suitable - max 27° C	Suitable - max 27° C	Suitable - max 27° C
Static electrical discharge	EN 1815	-	< 2 kV	< 2 kV	< 2 kV	< 2 kV Antistatic on concrete
Total VOC Emissions	AgBB/DIBt	$\leq 10 \mu\text{g}/\text{m}^3$ (after 28 days)	$\leq 10 \mu\text{g}/\text{m}^3$ (after 28 days)	$\leq 10 \mu\text{g}/\text{m}^3$ (after 28 days)	-	-
Acoustical absorption	NF EN ISO 354 $\alpha_w$	0.05 (H)	-	-	-	-
Electrical resistance	EN 1081	-	approx. $10^{10}$ Ohm	approx. $10^{10}$ Ohm	-	-
Chemical resistance	ISO 26987 - EN 423	Good	Good	Good	Good	Good
Bacteria resistance	ISO 846:Part C	-	Does not favour growth	Does not favour growth	Does not favour growth	-
Thermal resistance	EN 12667	0.01 m <sup>2</sup> K/W	approx. 0.01 m <sup>2</sup> K/W	approx. 0.01 m <sup>2</sup> K/W	approx. 0.01 m <sup>2</sup> K/W	0.01 m <sup>2</sup> K/W
Light fastness	EN ISO 105-B02	$\geq 6$	$\geq 6$	$\geq 6$	$\geq 6$	$\geq 6$
Slip resistance	DIN 51130	-	R10	R10	R10	-
	EN 13893	-	$\geq 0.3$	$\geq 0.3$	$\geq 0.3$	$\geq 0.3\mu$
Seam strength	EN 684	$\geq 200$	Average value: $\geq 240 \text{ N}/50 \text{ mm}$ Individual values: $\geq 180 \text{ N}/50 \text{ mm}$	Average value: $\geq 240 \text{ N}/50 \text{ mm}$ Individual values: $\geq 180 \text{ N}/50 \text{ mm}$	Average value: $\geq 240 \text{ N}/50 \text{ mm}$ Individual values: $\geq 180 \text{ N}/50 \text{ mm}$	Average value: $\geq 240 \text{ N}/50 \text{ mm}$
	Colours		32 + 2 borders	16	12	16

The above information is subject to modification for the benefit of further improvement. (03/16).  
The Tarkett Wetroom Concept encompasses a system of waterproof floor and wall coverings that will render a room completely watertight. It can negate the requirement for shower trays, and the accessories available will complete a design finish to a functional installation. It is essential that the product is installed fully to the manufacturers instructions. Maintenance instructions, recommended adhesives and further information are available from the technical department.

CUSTOMS TARIFF: 482050000000F

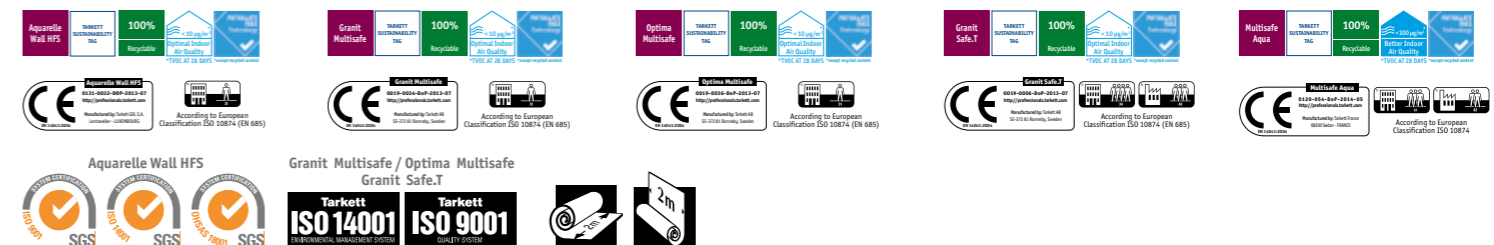

# REFERENCES

## WELDING RODS

REFERENCES	PLAIN WELDING RODS	MULTICOLOUR WELDING RODS	NCS	LUMINOUS REFLECTANCE VALUES
<b>GRANIT MULTISAFE</b>				
3476 379	1292379	1290041	S 4030-R90B	20.37 %
3476 382	1292 811	1290 028	NCS S 2502-B	49.05%
3476 383	1292 383	1290 021	NCS S 4502-B	28.60%
3476 740	1291542	1290149	S 5502-B	21.36 %
3476 741	1287255	1290150	S 3000-N	45.26 %
3476 742	1287446	1290151	S 1500-N	65.17 %
3476 743	1287391	1290143	S 3010-Y30R	41.32 %
3476 744	1287039	1290147	S 2010-Y20R	52.20 %
3476 745	1287178	1290146	S 3005-Y20R	42.38 %
3476 746	1287537	1290144	S 5005-Y20R	25.32 %
3476 747	1287519	1290148	S 2050-Y40R	35.84 %
3476 748	1287514	1290112	S 3030-R90B	27.91 %
3476 749	1287509	1290107	S 2030-B10G	40.24 %
3476 750	1287518	1290116	S 2030-G50Y	48.05 %
3476 751	1287298	1290070	S 1040-Y20R	59.81 %
3476 770	1288 255	1290 036	NCS S 1005-Y40R	71.32%
<b>OPTIMA MULTISAFE</b>				
3240 820	1287501	1290099	S 4010-Y30R	32.00 %
3240 838	1287509	1290107	S 2020-B10G	44.09 %
3240 845	1291845	1290034	S 8502-B	6.20 %
3240 848	1287514	1290112	S 3030-R80B	26.56 %
3240 853	1292388	1290022	S 3502-B	37.12 %
3240 860	1287039	1290066	S 2010-Y20R	52.20 %
3240 861	1287518	1290116	S 2040-G60Y	45.24 %
3240 863	1287519	1290117	S 2050-Y40R	35.84 %
3240 866	1291216	1290026	S 6502-B	15.11 %
3240 873	1287524	1290122	S 3502-Y	38.15 %
3240 874	1287525	1290123	S 5502-Y	21.62 %
3240 886	1291609	1290049	S 1500-N	65.17 %
<b>GRANIT SAFE.T</b>				
3052 690	1287249	1290056	S 1040-Y30R	56.37 %
3052 691	1288255	1290036	S 1005-Y40R	71.32 %
3052 692	1287407	1290023	S 2010-Y30R	56.23 %
3052 693	1292375	1290046	S 3030-Y50R	31.53 %
3052 694	1287332	1290059	S 3020-G30Y	36.90 %
3052 695	1291210	1290038	S 2020-R90B	44.17 %
3052 696	1292379	1290041	S 4030-R90B	20.37 %
3052 697	1291811	1290028	S 2502-B	49.05 %
3052 698	1292383	1290021	S 4502-B	28.60 %
3052 699	1299327	1290027	S 6502-B	15.10 %
3052 700	1292384	1290035	S 8502-B	6.20 %
3052 702	1287391	1290143	S 3010-Y30R	41.32 %
3052 703	1287298	1290070	S 1040-Y20R	59.81 %
3052 704	1287537	1290144	S 5005-Y20R	25.32 %
3052 705	1287298	1290070	S 2030-G50Y	48.05 %
3052 706	1287509	1290107	S 2030-B10G	40.24 %

REFERENCES	PLAIN WELDING RODS	NCS	LUMINOUS REFLECTANCE VALUES
<b>MULTISAFE AQUA</b>			
25910 000	24806 090	S1505-Y40R	55,92%
25910 001	24806 091	S3502-Y	36,48%
25910 002	24806 092	S4502-Y	24,2%
25910 003	24806 093	S3005-Y50R	37,96%
25911 000	24806 094	S6005-Y20R	20,01%
25911 001	24806 095	S2050-Y10R	47,71%
25911 002	24806 096	S2050-G70Y	48,03%
25911 003	24806 097	S3040-R90B	18,29%
25912 202	24806 099	S4005-Y50R	27,53%
25912 203	24806 098	S3020-Y10R	37,77%
25912 205	24806 100	S5010-R30B	17,29%
25912 206	24806 101	S4020-B	19,04%
<b>AQUARELLE WALL HFS</b>			
3942 027	24806 013	S 0510-Y20R	67.10 %
3942 031	24806 014	S 1005-Y50R	66.30 %
3942 033	24806 015	S 1000-N	68.70 %
3942 034	24806 016	S 0500-N	71.30 %
3942 037	24806 017	S 0300-N	80.30 %
3942 038	24806 001	S 1515-Y30R	50.20 %
3942 039	24806 007	S 7020-Y60R	4.20 %
3942 040	24806 009	S 0603-Y20R	73.80 %
3942 041	24806 002	S 2005-Y50R	47.50 %
3942 042	24806 004	S 6005-Y50R	12.80 %
3942 043	24806 003	S 3500N	28.40 %
3942 044	24806 006	S 7000N	9.70 %
3942 045	24806 008	S 3060-B20G	14.20 %
3942 046	24806 005	S 4050-R90B	9.10 %
3942 047	24806 010	S 1040-G60Y	50.40 %
3942 048	24806 011	S 1070-Y50R	31.30 %
3942 049	24806 012	S 2570-Y80R	8.80 %
3942 050	24806 018	S 1500-N	55.30 %
3942 051	24806 019	S 3502-B	34.10 %
3942 052	24806 020	S 2002-Y	47.70 %
3942 053	24806 021	S 3502-Y	30.10 %
3942 054	24806 022	S 1510-Y10R	55.80 %
3942 055	24806 023	S 2010-Y10R	49.70 %
3942 056	24806 024	S 0550-Y20R	55.70 %
3942 057	24806 025	S 2020-R80B	43.20 %
3942 058	24806 026	S 0500-N	68.50 %
3942 059	24806 027	S 2005-Y20R	39.50 %
3942 060	24806 028	S 4005-Y20R	19.10 %
3942 061	24806 029	S 5005-Y50R	24.90 %
3942 062	24806 030	S 1060-G60Y	44.10 %
3942 063	24806 031	S 1050-Y20R	46.80 %
3942 064	24806 032	S 3040-R90B	23.40 %

# GUARANTEE

## APPLICATION

The 10-year guarantee runs from receipt of the product by the contractor, on condition that the work is carried out according to the specifications and Technical Assessment.

The Wetroom Concept is a Technical Assessment (n° 12/11-1599) procedure on the green list (without observation) of the Construction Quality Agency's (AQC) Product Safety Commission (C2P). A 10-year insurance policy is therefore required and applied without any additional conditions (consult your own insurance contract). Tarkett's Wetroom Concept is covered by a 10-year guarantee (construction material manufacturers) with AXA insurance.

## CONTRACTORS

The success of the Wetroom concept rests on more than 25 years of high quality installations. We recommend that contractors only use installers with experience in the Wetroom concept.



# MAINTENANCE

## FLOORING CARE: MULTISAFE GRANIT OR GRANIT SAFE.T OR MULTISAFE OPTIMA

### BEFORE USE

Vacuum clean the flooring.  
Clean with an alkaline (pH 8/10) detergent and a scrubbing brush or a low speed cleaning machine with a nylon brush.  
Rinse with clean water.

### DAILY CARE

Wash by hand with a neutral (pH 6/8)\* detergent.  
Periodic care/Return to original condition.  
Wash with an alkaline (pH 8/10) detergent and a scrubbing brush or a low speed cleaning machine with a nylon brush.  
Rinse with clean water.

## RECOMMENDED PRODUCTS

**Neutral detergent:** Jontec Asset, 300 (Diversey), Dynatech Clean Force (Tana Professional), or similar  
**Alkaline detergent:** Jontec Stride Degreaser (Diversey), Dynatech Alka (Tana Professional), or similar  
**Descaling detergent:** Sani Acid (Diversey), Dynatech Calc Off (Tana Professional), or similar  
**Disinfectant detergent:** Sprint Degragerm (Diversey), Dynatech Clean Bacto (Tana Professional), or similar.

## WALL COVERING CARE: AQUARELLE WALL HFS

Wash with a neutral (pH 6/8)\* detergent. Don't use an abrasive pad.  
Rinse with fresh water.

WATERPROOF  
SYSTEM

# WETROOM CONCEPT

## ■ WESTERN EUROPE

**Austria** Tarkett Holding GmbH,  
Niederlassung Wien – Tel. +43 1 47 88 062

**Belgium** Tarkett France Belux  
Tel. +32 16 35 98 80

**Denmark** Tarkett A/S – Tel. +45 43 90 60 11

**Finland** Tarkett Oy – Tel. +358 9 4257 9000

**France** Tarkett SAS – Tel. +33 1 41 20 42 49

**Germany** Tarkett Holding GmbH, Bereich  
Objekt – Tel. +49 62 33 810

**Greece** Tarkett Monoprosopi Ltd  
Tel. +30 210 6745 340

**Italy** Tarkett S.p.A. – Tel. +39 0744 7551

**Luxembourg** Tarkett GDL SA  
Tel. +352 949 211 8804

**Netherlands** Tarkett Holding GmbH,  
Vestiging Nederland – Tel. +31 76 57 80 760

**Norway** Tarkett AS – Tel. +47 32 20 92 00

**Portugal** Tarkett SA – Tel. +351 21 427 64 20

**Spain** Tarkett Floors S.L  
Tel. +34 91 358 00 35

**Sweden** Tarkett Sverige AB  
Tel. +46 771 25 19 00

**Switzerland** Tarkett Holding GmbH, Bereich  
Objekt Schweiz – Tel. +41 043 233 79 24

**Turkey** Tarkett Aspen – Tel. +90 212 213 65 80

**United Kingdom** Tarkett Ltd  
Tel. +44 (0) 1622 854 040

## ■ EASTERN EUROPE

**Baltic Countries** Tarkett Baltics  
Tel. +370 37 262 220

**Czech Republic** Tarkett France SAS, org.  
slozka – Tel. +420-271 001 602

**Hungary** Tarkett France SAS  
Tel. +36 1 437 8150

**Poland** Tarkett Polska Sp. z o. o.  
Tel. +48 22 639 31 68

**Russian Federation** ZAO Tarkett RUS  
Tel. +7 495 775 3737

**Slovakia** Tarkett France SAS, org.zlozka  
Tel. +421 248 291 317

**South East Europe** Tarkett Trade d.o.o.  
Tel. +381 21 7557 649 (44) 569 12 21

**Ukraine** Tarkett UA  
Tel: +38 (0) 44 569 12 21

## ■ ASIA AND OCEANIA

**Australia** Tarkett Australia Pty Ltd  
Tel. +61 2 88 53 12 00

**China** Tarkett Floor Covering (Shanghai) Co.  
Ltd. – Tel. +86 (21) 60 95 68 38 ext 841

**North East Asia** Tarkett Hong Kong Limited  
Tel. +852 2511 8716

**India** Tarkett France (India Branch)  
Tel. +91 11 4352 4073

**South East Asia** Tarkett Flooring Singapore  
Pte. Ltd. – Tel. +65 6346 1585

## ■ AFRICA

**Tarkett International**  
Tel. +33 1 41 20 41 01

## ■ MIDDLE EAST

**Tarkett Middle East**  
Tel. +961 1 51 3363/4

**Israel** Tarkett International  
Tel. +33 1 41 20 41 01

## ■ NORTH AMERICA

**USA** Tarkett Inc. – Tel. +1 713 869 5811 /  
Johnsonite – Tel. +1 440 543 8916

**Canada** Tarkett Inc. – Tel. +1 450 293 173

## ■ LATIN AMERICA

**Brazil** Tarkett – Tel. 55 12 3954 7108

**Argentina - Chile - Uruguay**  
Tarkett Latam Mercosur  
Tel. 54 11 47 08 07 72 / 54 9 11 44 46 88 82

**Colombia - Panama - Bolivia - Ecuador -  
Paraguay - Peru - Trinidad and Tobago**  
Tarkett - Tel. 55 11 9 8410 9310

**Mexico /Central America**  
Tarkett Latam Mexico - Tel. 52 735 392-3948